

Six Channel Modular Receiver

Featuring Digital Hybrid Wireless® Technology



- 3-block tuning for up to 76 MHz and 3072 synthesized UHF frequencies per receiver module
 - Six-channel modular configuration
 - Ratio or Antenna Phase diversity reception
 - IR port for quick transmitter setup
 - DSP emulation modes for compatibility with analog wireless systems in addition to the Digital Hybrid mode
 - iQ™ dynamic tracking filters for enhanced RF performance
 - Wireless Designer™ setup and control software included
 - Talkback function with select transmitters
 - Ethernet, USB and RS-232 computer interface ports
- **Two versions available:**
 - VRM2WBL** tunes bands A1, B1, C1, and others in tuning range 470.100 to 691.175 MHz
 - VRM2WBM** tunes bands B1, C1, D1, and others in tuning range 537.600 to 767.975 MHz

The Venue 2 Receiver is a modular solution that effectively deals with a congested RF spectrum with a variety of options that allows a system configuration to be idealized for a particular installation or application.

The receiver is comprised of several components:

- The master rack mount host assembly
- Up to six receiver modules
- Built-in antenna multicoupler with loop-thru output
- Software for setup and control

Flexibility is the core concept of the design. The receiver modules can be operated separately, each with switched diversity reception for a total of six audio channels, or operated in pairs for more robust diversity reception with one audio channel per module pair. Combinations can also be used for special applications where some modules operate independently and others are paired.

The receiver modules are easy to change with no tools required. The wideband multicoupler allows the use of any frequency module in any position, except when modules are paired for ratio diversity reception.

A major benefit of the design is the inclusion of a high quality antenna multicoupler. The multicoupler is actually a dual 1 in, 7 out splitter with six outputs for the receiver modules and an additional output as a “loop thru” for another Venue receiver. This allows multiple Venue receivers to operate from a single pair of antennas. Phantom power for remote antenna amplifiers is available from the multicoupler antenna inputs via menu selection.

Digital Hybrid Wireless®

is a revolutionary design that combines digital audio with an analog FM radio link to provide both outstanding audio quality and exemplary, noise-free RF performance.

Using a patented algorithm to encode 24-bit digital audio information in the transmitter into an analog format, the encoded signal is then transmitted over an analog FM wireless link.

At the receiver, the signal is then decoded to restore the original digital audio. This process eliminates compandor artifacts and produces an audio frequency response flat to 20 kHz.

(US Patent 7,225,135)

Front Panel

The front panel provides an easy-to-use LCD interface for setup, and provisions for quick monitoring to assist in troubleshooting. In normal operation, the LCD shows RF and audio levels, diversity status, pilot tone status (where applicable) and transmitter battery status for all six receivers at the same time.

Individual screens for each receiver are also available at the touch of a button to provide additional information and setup adjustments. A headphone jack and level control is provided for individual channel monitoring. A USB jack allows for monitoring, control, and firmware updates. An IR port provides for quick transmitter sync setup.



Rear Panel

The rear panel provides six balanced audio outputs on standard XLR connectors, 50 ohm BNC antenna inputs, 50 ohm BNC antenna outputs from the built in zero-gain multicoupler, power jack with a locking connector, Ethernet port and RS-232 serial port for the computer inter-

face. The receiver assembly is powered from an external source at 10 to 18 volts DC through a locking connector, allowing the unit to operate from a wide variety of sources in stage, studio and mobile applications.

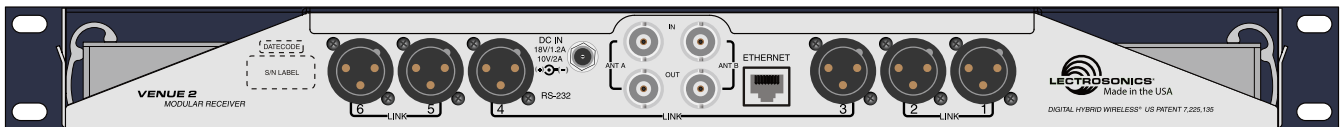

Receiver Module

The receiver module features a unique design that tunes across a range of over 76 MHz (less than this in some tuning ranges - see specs). IQ™ dynamic tracking filters are employed to suppress RF signals above and below the carrier. The filters automatically shift to stay centered over the selected frequency and adjust to RF levels.

The modules are a triple conversion, frequency synthesized design, controlled by the microprocessor in the host assembly. A common DSP in the host assembly is used for all six receiver modules to decode the received signals and restore the digital audio. Using a single DSP results in a significant reduction in cost per channel.

The host assembly will handle up to six receiver modules via multi-pin connectors on the side of the main housing. The modules are held in place with snap-in retaining clips. The clips hold the modules firmly but are easy to remove without tools to make needed changes.



Module Pairing

Each module can provide a single audio output channel using SmartDiversity™ antenna phase combining. For more robust ratio diversity reception, two adjacent modules can be paired, with both of them delivering the same audio signal at each of their outputs. The pairing requires that the modules be in adjacent positions in the mainframe chassis.

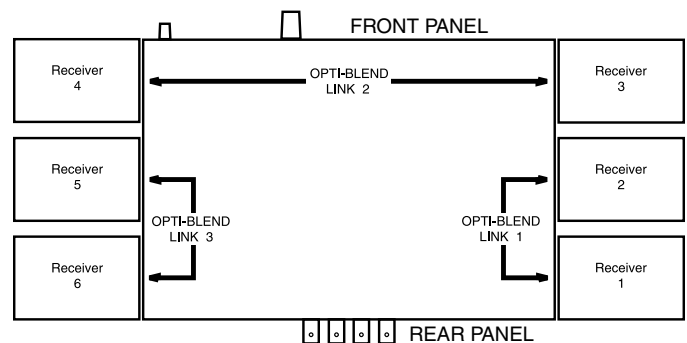

Ratio diversity employs a panning action that blends the RF signals from the two receivers over a fairly wide range of levels to eliminate dropouts before they occur. The process is called OptiBlend™ as indicated on the label on the receiver chassis.

Built-in Antenna Multicoupler

Every Venue receiver has a built-in multicoupler that utilizes high current RF amplifiers and a Wilkinson type splitter for even signal distribution and high isolation between receiver modules. Optimally matched levels allow multiple receivers to be stacked and share a single pair of antennas - a significant savings in space and cost in multi-channel systems.

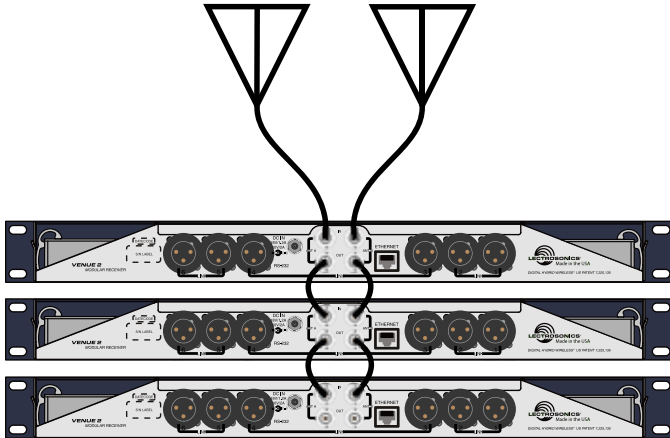

The built-in multi-coupler includes "loop through" outputs for stacking multiple Venue receivers.

Two versions are available in different frequency ranges:

- Wideband Mid (537 - 768 MHz)
- Wideband Low (470 - 691 MHz)

Antenna BNC Connectors and Power

The Antenna input jacks can be front- or rear-mounted by simply moving the jacks to the appropriate location. This does require opening the top cover.

Remote antenna amplifiers can be powered by DC on the coaxial cable between them and the receiver. A menu item turns the power on and off.

The DC voltage from the receiver main power supply is passed through to the BNC connectors.

IMPORTANT: 16 VDC is the maximum voltage that Lectrosonics antenna amplifiers can use. The VRM2 receiver power input can handle up to 18 VDC. If antenna power is enabled, use only 16 VDC or less to power the receiver.

Computer Connections

The Venue receiver can be connected to a computer via the Ethernet or USB ports. Multiple receivers can be connected to a single computer using a hub or switch. The receiver also provides an RS-232 serial port.

Single USB or Ethernet Connection



Multiple Connections via Hub or Switch

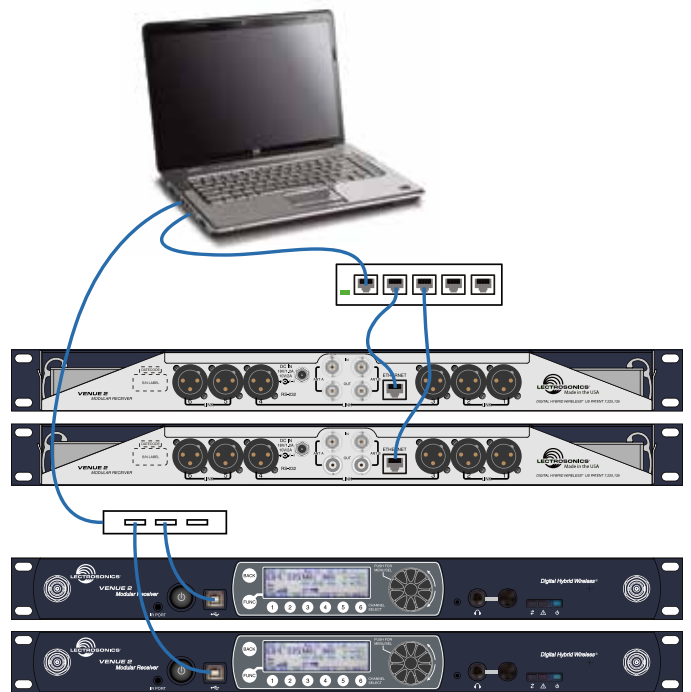

LCD Menus

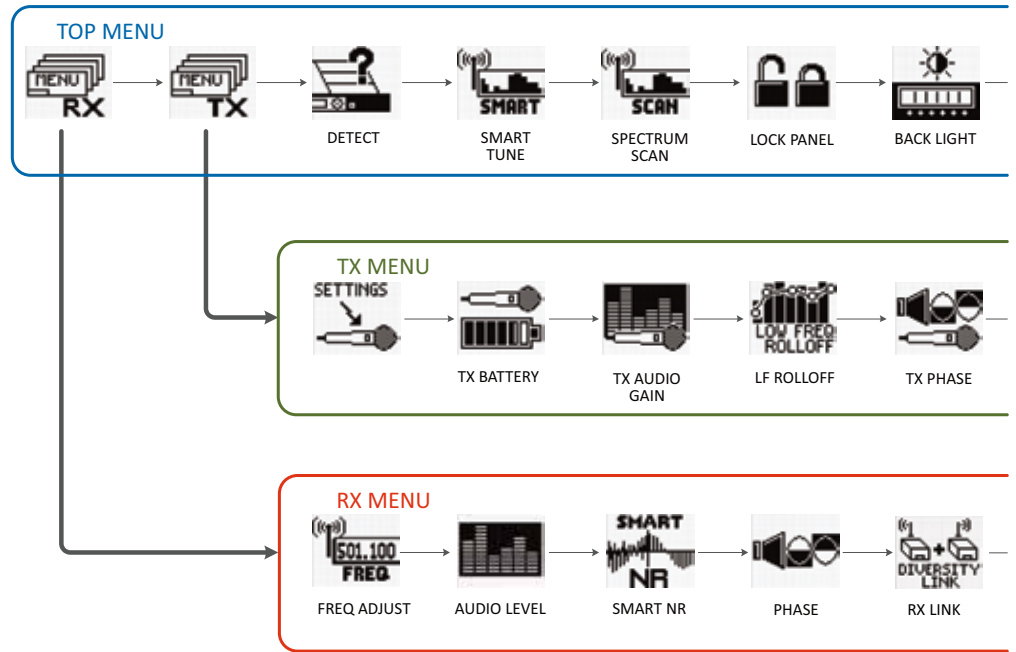

Wireless Designer Software

The supplied software simplifies setup and exposes all features in an easily navigable GUI. Each 6-channel frame is depicted on the left side of the screen, with individual setup screens for each channel displayed in a larger edit window. Double left click or right click on a channel to open a dialog box and make settings.

Other features include spectrum scanning and frequency coordination. The spectrum scan data can be imported into the frequency coordination calculations to provide a thorough analysis and cleanly operable frequencies.

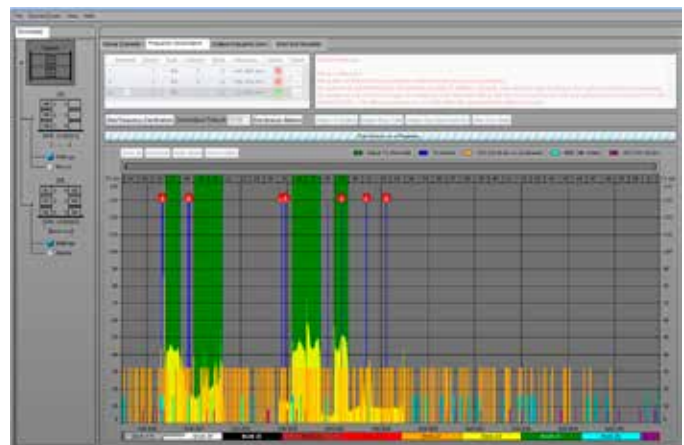
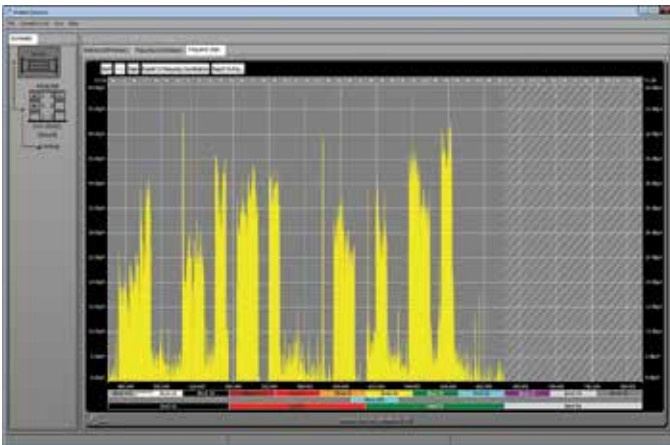

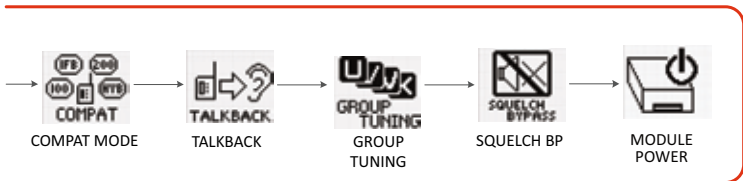
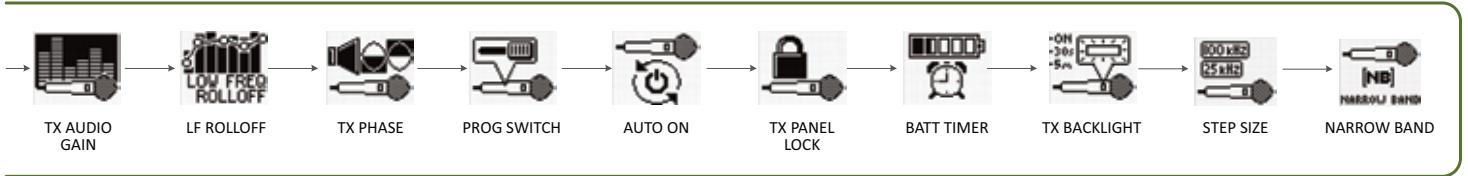
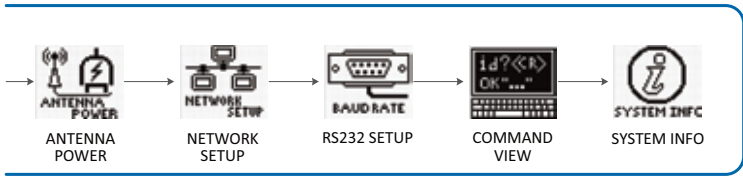



The “Q” of a filter refers to its bandwidth. The narrower the bandwidth, the higher the Q value. It is typical that a narrower filter will also introduce more loss. iQ is a dual-mode front-end filter that automatically switches from a normal tracking filter bandwidth to higher Q (narrower filter) with additional loss when the **desired transmitter signal** is above a certain level. The narrow mode allows the front-end to enhance the IP3 performance of the receiver with frequencies much closer to the carrier than what conventional front-end filters can provide. When the incoming transmitter signal drops below a certain point, the filter switches back to the normal mode for extended operating range.

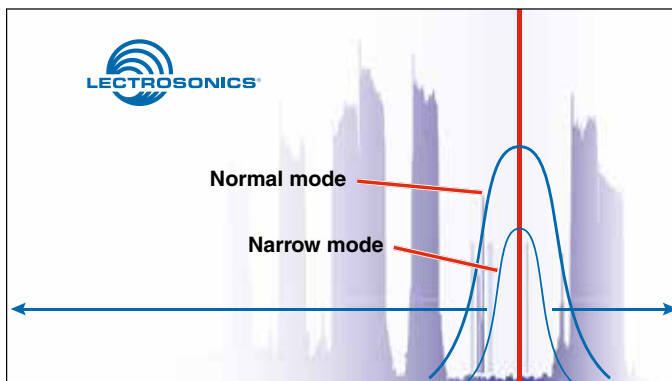

IP3 is used as a measure of a receiver’s ability to reject strong RF signals near the operating frequency of a wireless system. When two signals that can generate IMD3 (third order IM) are even a few MHz away from the carrier, the iQ filter in the narrow mode suppresses them significantly. The already excellent IP3 performance of the receiver with the iQ filter in the normal mode is further improved when the filter switches to the narrow mode.

Typical IP3 values for the VRT2 receiver module:

Wide mode	+5dBm
Narrow mode	+12dBm

The iQ filter tracks in very fine increments across the 76 MHz tuning range of the module to stay centered on the carrier frequency. There are over 50 steps across the tuning range, so essentially the filter moves in a continuous manner.

The circuitry was specifically designed to prevent any audible transients (“clicks”) from being injected into the audio signal when the switching takes place. The LCD on the Venue 2 front panel provides an icon to indicate which mode is being employed.

Diversity Modes

The modular configuration enables several types of diversity reception for various applications. The modules can be used individually for switched diversity reception with each module delivering an audio output, or coupled into pairs for more robust ratio diversity reception where each module pair delivers one audio channel.

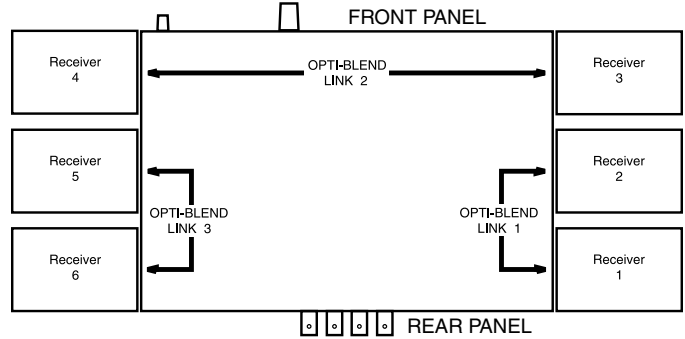

SmartDiversity™ allows each receiver to run independently to provide two separate audio channels. The algorithm analyzes both the incoming RF level and the rate of change in RF level to determine the optimum timing for phase switching, and the optimum antenna phase. The system also employs “opportunistic switching” to analyze and then latch the phase in the best position during brief squelch activity. Enhancements to this design as employed in the Venue 2 system further reduce any switching noise when compared to previous versions.

Ratio Diversity blends the audio outputs of both receivers in a seamless manner to produce a single audio output. A panning circuit blends more signal from the receiver with the stronger RF signal over a wide RF level range to anticipate and eliminate dropouts long before they occur. When a good RF signal is present at both receivers and the audio is blended equally, the signal-to-noise ratio is increased by 3 dB.

DSP-Based Pilot Tone

A pilot tone is generated in the transmitter and delivered to the receiver along with the program audio. The receiver needs to detect both a valid RF signal and the unique pilot tone before the squelch will open and the program audio will be present at the receiver output.

The Digital Hybrid system design uses an ultrasonic pilot tone generated by the DSP to control the receiver squelch, with a different pilot tone frequency for each operating frequency. This eliminates squelch problems in multi-channel systems where a pilot tone signal can appear in the wrong receiver via IM.

SmartNR™

A unique benefit of Digital Hybrid Wireless™ is a DSP-based algorithm that address high frequency noise in the audio. With a noise floor at -120 dBV and a frequency response to 20 kHz, high frequency noise in the source audio is more apparent than in conventional wireless systems.

The Smart Noise Reduction algorithm works by attenuating only those portions of the audio signal that fit a statistical profile for randomness or “electronic hiss.” Because it isn’t simply a sophisticated variable low pass filter as in earlier analog designs, much greater transparency is obtained. Desired high frequency signals having some coherence such as speech sibilance and tones are not affected.

The algorithm has three modes, selectable from the front panel LCD and the software GUI:

- OFF - no noise reduction is performed.
- NORMAL - the factory default setting; enough noise reduction is applied to remove most of the hiss from the mic preamp and some of the hiss from lavalier microphones.
- FULL - enough noise reduction is applied to remove most of the hiss from nearly any signal source of reasonable quality, assuming levels are set correctly at the transmitter.

power distribution and rack mount into a single 1RU assembly for all six channels.

Inside the main assembly, the encoded radio signals in the receiver modules are sent to the DSP for decoding and restoration of the 24-bit digital audio signals generated in the transmitters.

The microprocessor communicates with the operator through the front panel controls, and the USB and serial ports when connected to a computer. It also sends and receives control signals and data from the receiver modules and the DSP.

The DSP handles the “number crunching” to restore the digital audio from the encoded signals and communicates pilot tone status to the microprocessor. Once the digital audio is restored, it is finally converted to analog and delivered to the outputs, with control signals from the microprocessor setting the output levels.

Block Diagram

The Venue receiver uses a common microprocessor and DSP for all six receiver modules. This modular design reduces the cost per channel significantly, and saves rack space by combining a 7-way antenna multicoupler,

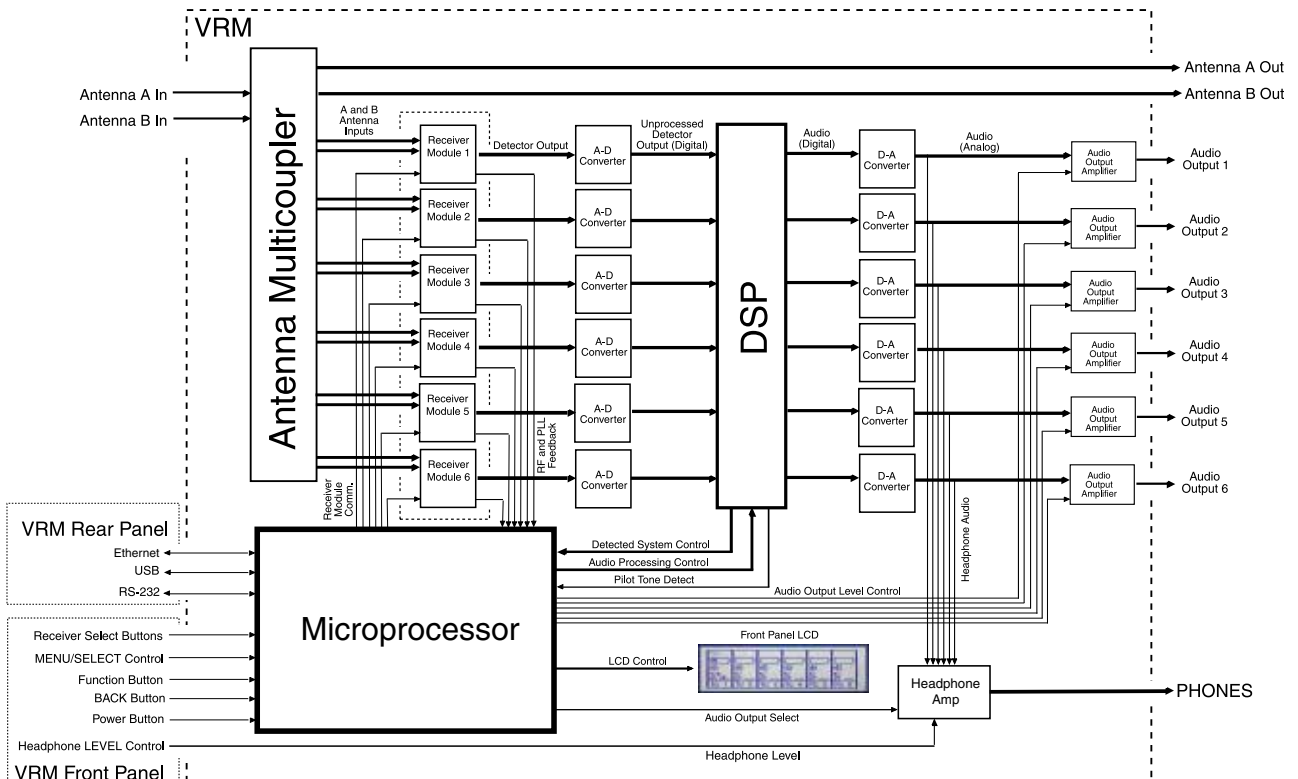

Specifications

Operating Frequencies - Host Mainframe

VRM2WBL: Tunes to bands A1, B1, C1
VRM2WBM: Tunes to bands B1, C1, D1**

Operating Frequencies - VRT2 Module

Band A1: 470.100 - 537.575 MHz (blocks 470, 19, 20)
Band B1: 537.600 - 614.375 MHz* (blocks 21, 22, 23)
Band C1: 614.400 - 691.175 MHz (blocks 24, 25, 26)
Band D1**: 691.200 - 767.975 MHz (blocks 27, 28, 29)

*North American transmitter models exclude the radio astronomy band from 608 to 614 MHz.

**Export only. Not available in the US.

Frequency selection: Up to 3072 frequencies

Frequency selection steps: Selectable; 100 kHz or 25 kHz

Digital latency:

- 1.5 mS (receiver only - hybrid mode)
- 3.0 mS (receiver and transmitter in hybrid mode)
- 3.0 mS (receiver only - analog compatibility mode)

The 3.0 mS latency in analog compatibility mode time aligns the audio from analog and hybrid transmitters when they are used together in a Venue system.

Wideband Multicoupler: Built in antenna multicoupler covers a 230 MHz range.

Pilot tone: 25 to 32 kHz; 5kHz deviation; unique pilot tone frequency for each selected carrier frequency (Hybrid mode)

Deviation: ± 75 kHz (max) (Hybrid mode)

Receiver Type: Triple conversion superheterodyne

Frequency Stability: ± 0.001 %

Multicoupler Bandwidth: 470 - 691 MHz or 537 - 768 MHz

Front End Bandwidth:

- iQ filter wide mode: 15 MHz
- iQ filter narrow mode: 10 MHz

Sensitivity (20 dB Sinad): 0.9 μ V

AM Rejection: >60 dB, 2 μ V to 1 Volt

Image and Spurious

Rejection: 85 dB

Third Order Intercept:

- iQ filter wide mode: +5 dBm
- iQ filter narrow mode: +12 dBm

Diversity Methods:

- Antenna Combining Phase switching
- Opti-blend™ ratio diversity

FM Detector: Digital pulse counting detector @ 300 kHz

Audio Performance (overall system):

Frequency Response: 32 Hz to 20 kHz (+/-1dB), overall system (400 Series mode)

THD: 0.2% (typical) (400 Series mode)

SNR at receiver output (dB) In Hybrid operating mode:

SmartNR	No limiting	w/ Limiting
OFF	103.5	108.5
NORMAL	107.0	111.5
FULL	108.5	113.0

(Note: the dual envelope "soft" limiter provides exceptionally good handling of transients using variable attack and release time constants. The gradual onset of limiting in the design begins below full modulation, which reduces the measured figure for SNR without limiting by 4.5 dB).

Input Dynamic Range: 125 dB (with full transmitter limiting)

Audio Output Level: -35 dBu to +8 dBu, in 1 dB increments

LCD: High resolution graphical display

Power Requirements: 10 VDC/2A to 18 VDC/1.2A

Weight: 4.4 lbs. (1984 grams) with six modules

Dimensions: 19"W x 1.75"H x 7.75"D (panel to rear jacks)
(48.26 cm x 4.45 cm x 19.67 cm)

Specifications and Features subject to change without notice.

Note: Some specifications apply only when the receiver is operating in the Digital Hybrid (400 Series) mode.

